

# F-16

razpon – 126 cm  
 dolžina – 146 cm  
 površina – 40 dm<sup>2</sup>  
 masa – 1400 g  
 nosilnost – 35 g/dm<sup>2</sup>  
 motor – speed 600

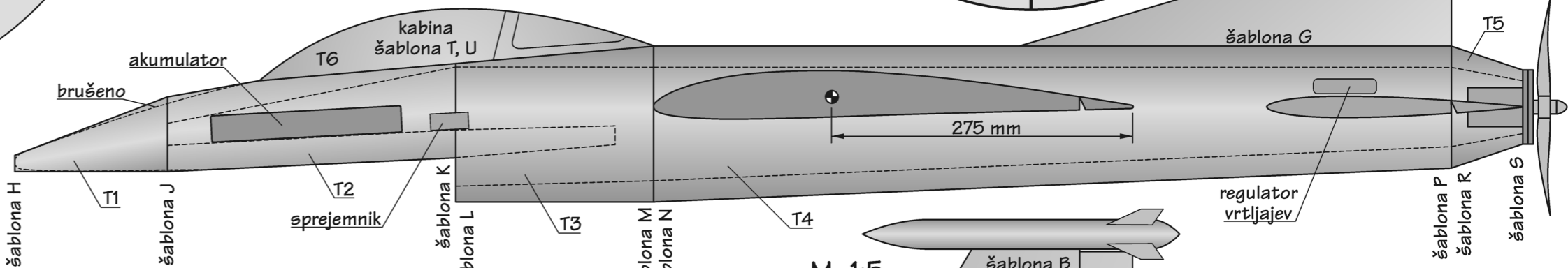

M=1:1

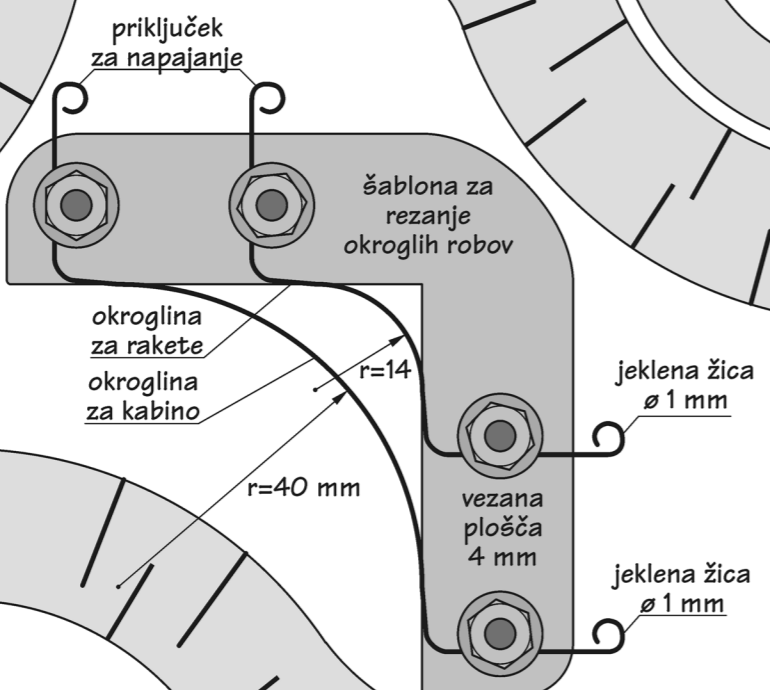
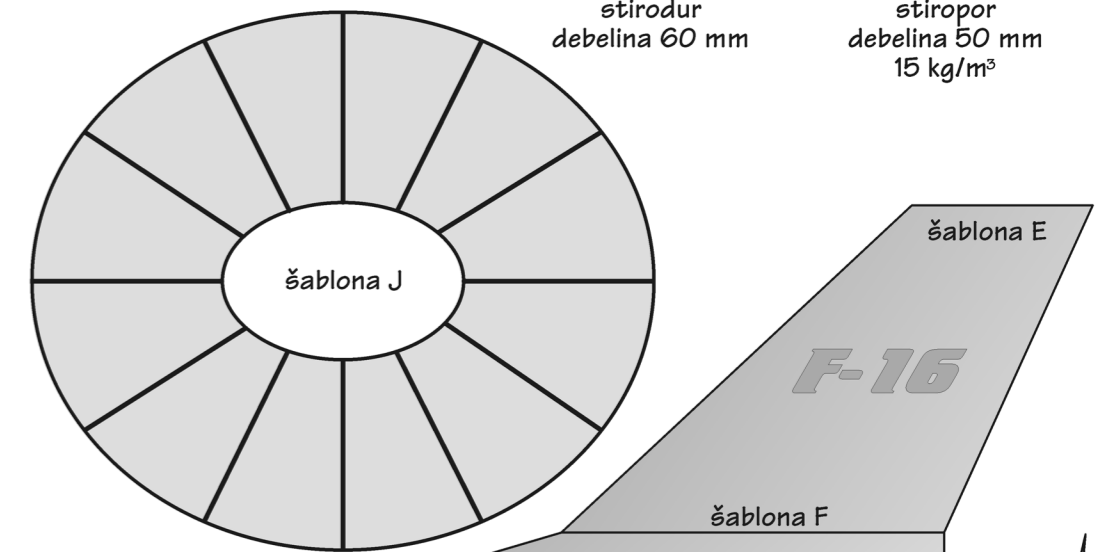
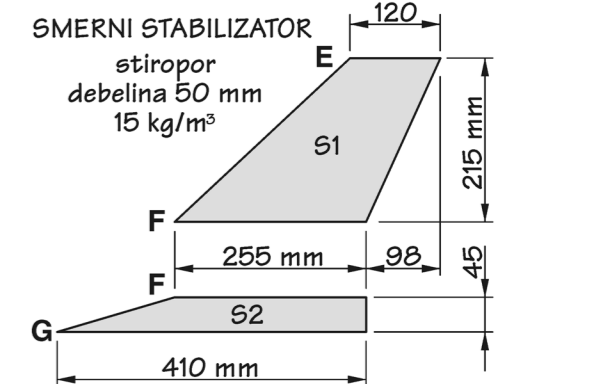
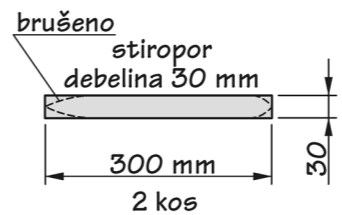
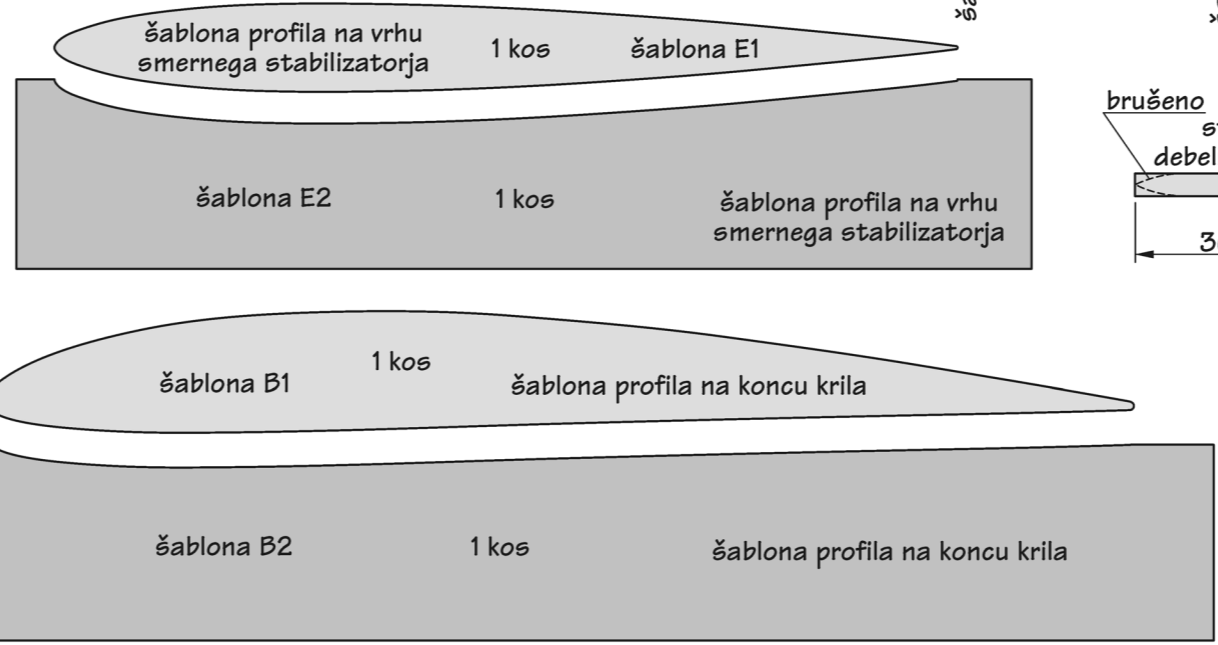
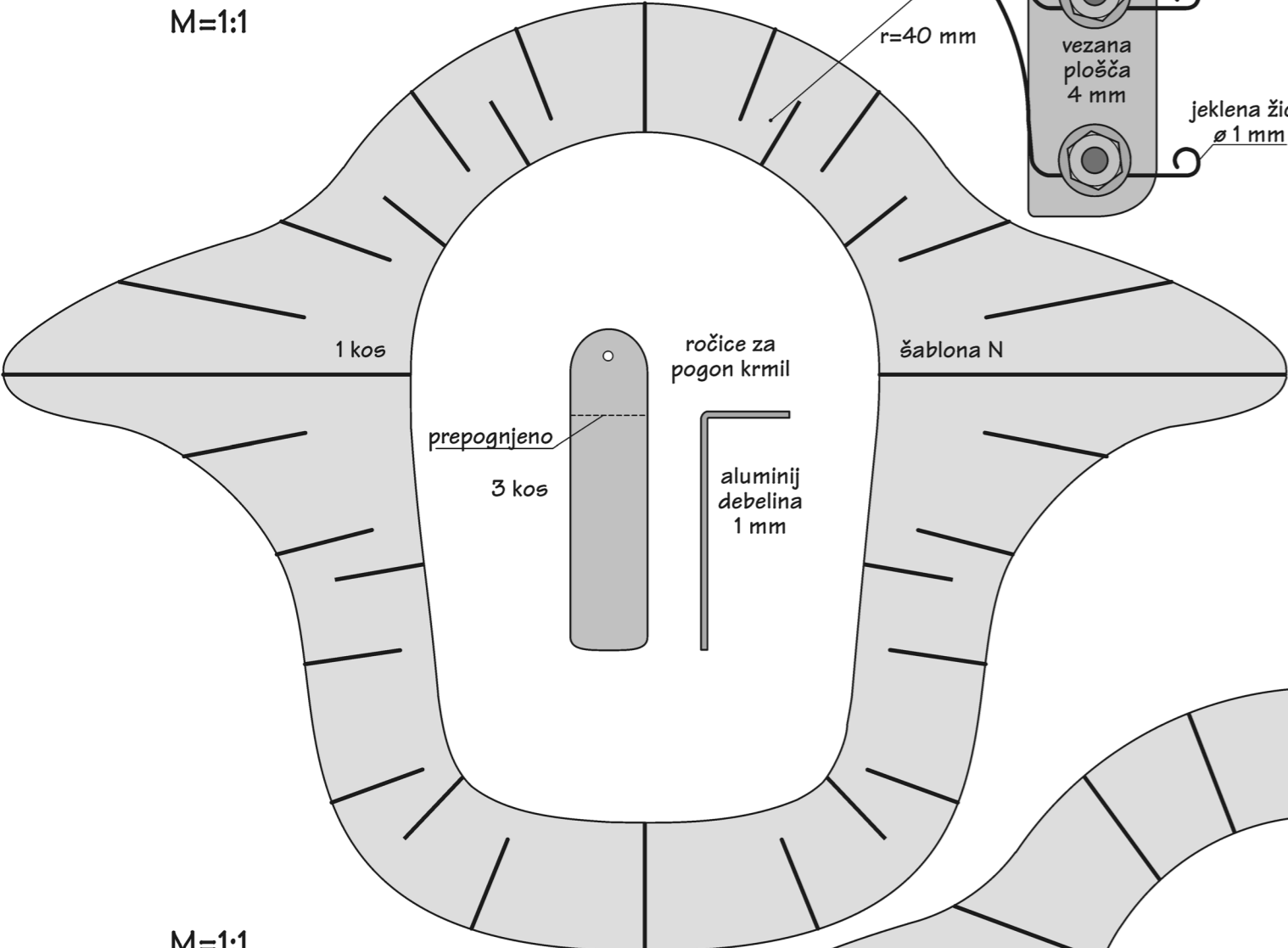

M=1:1

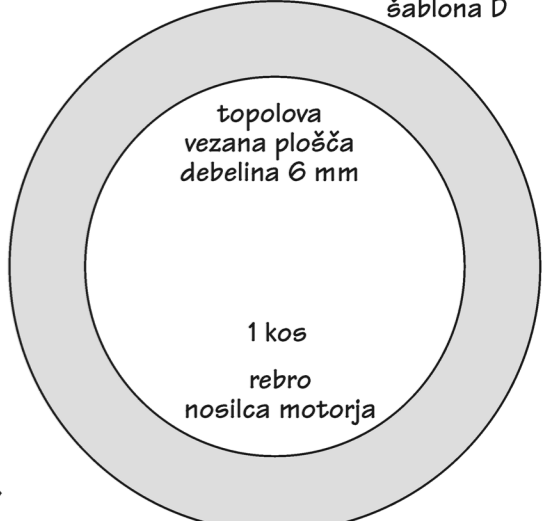
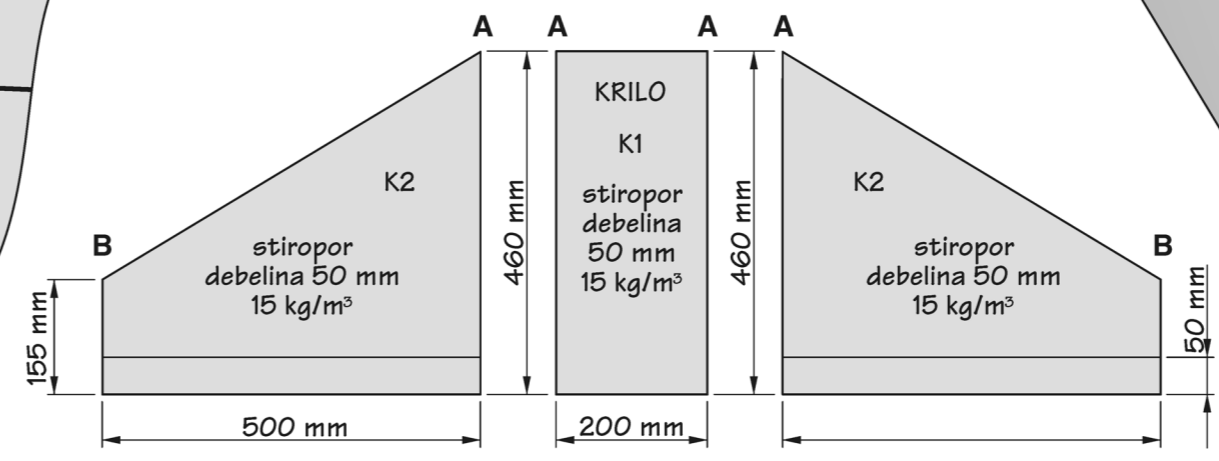
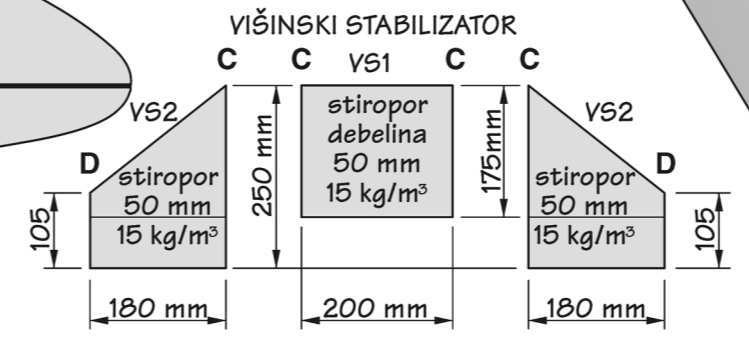
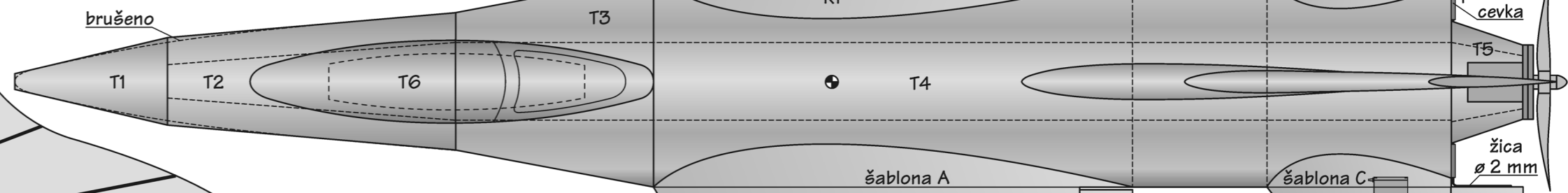
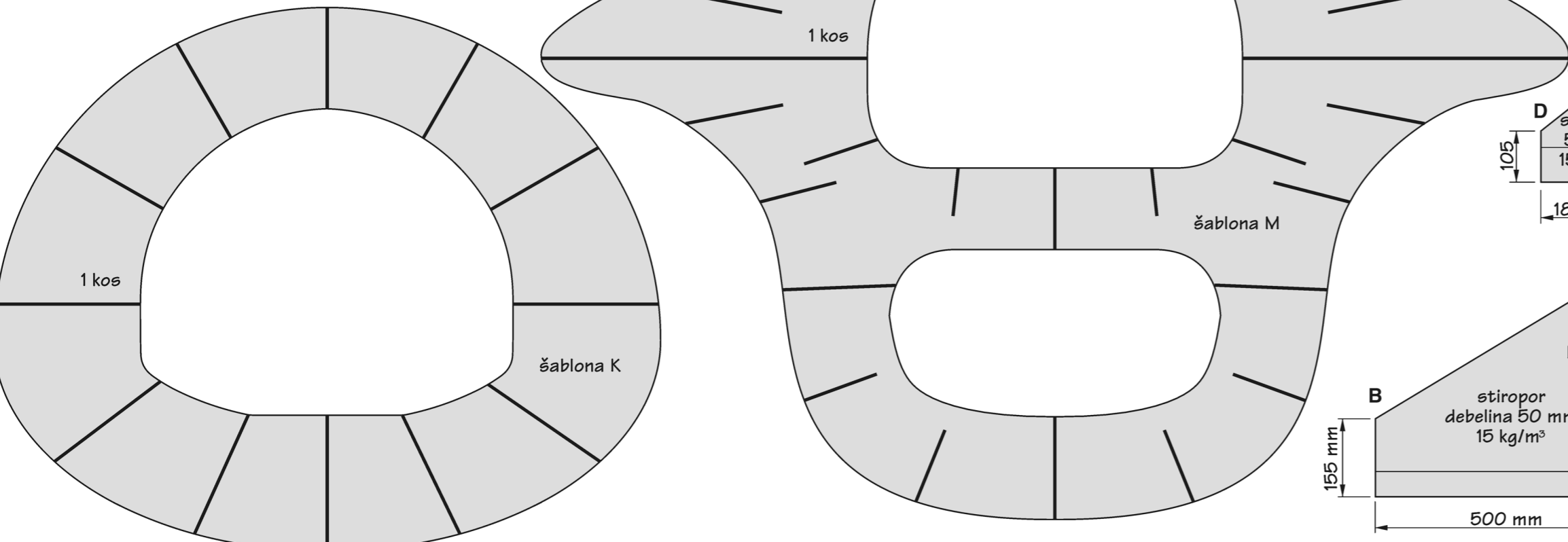

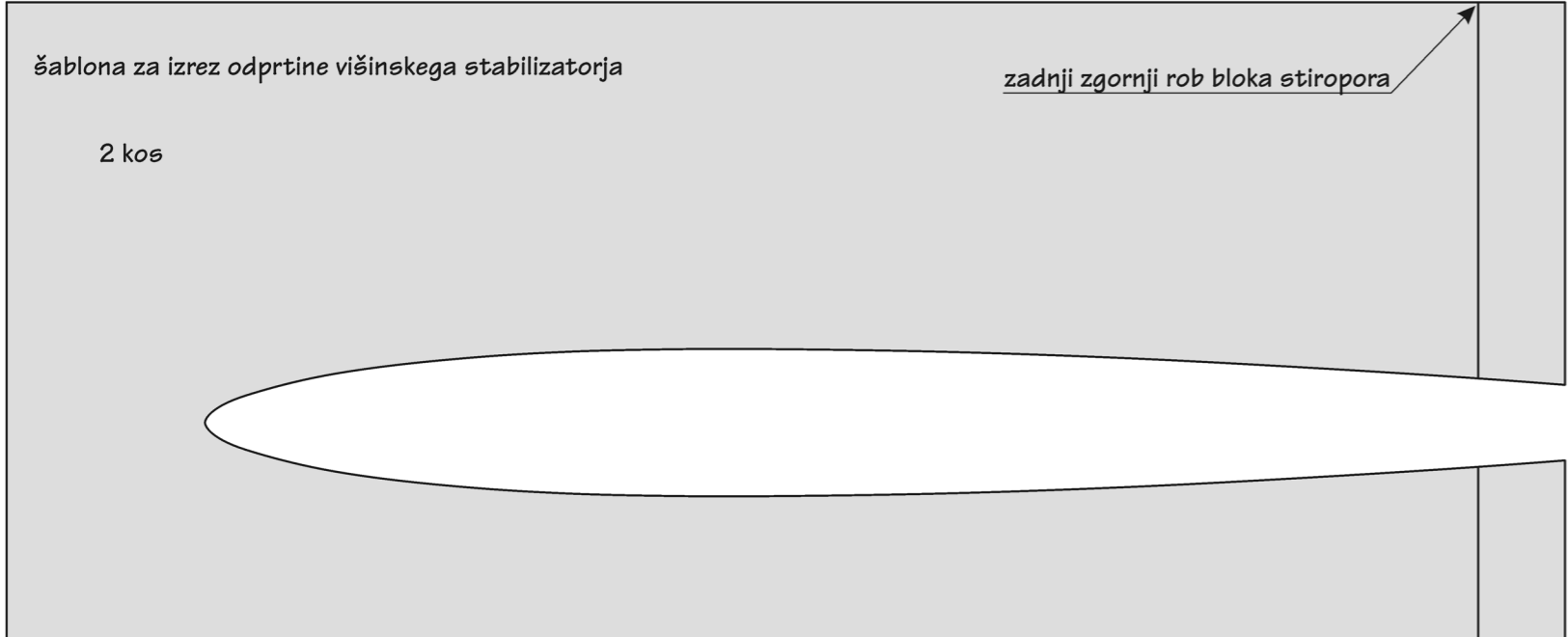

M=1:1

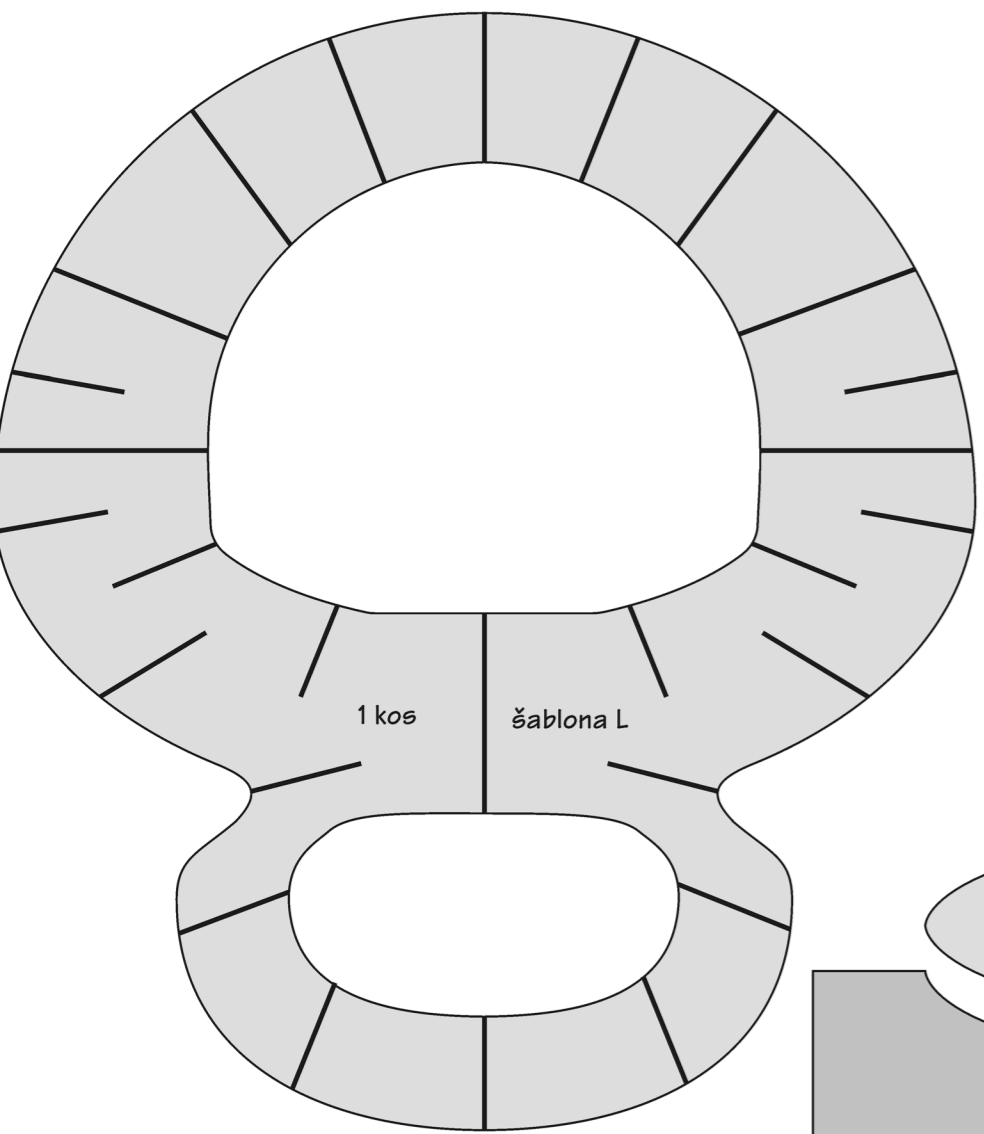
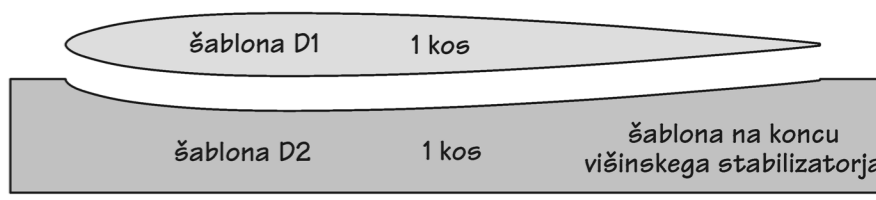
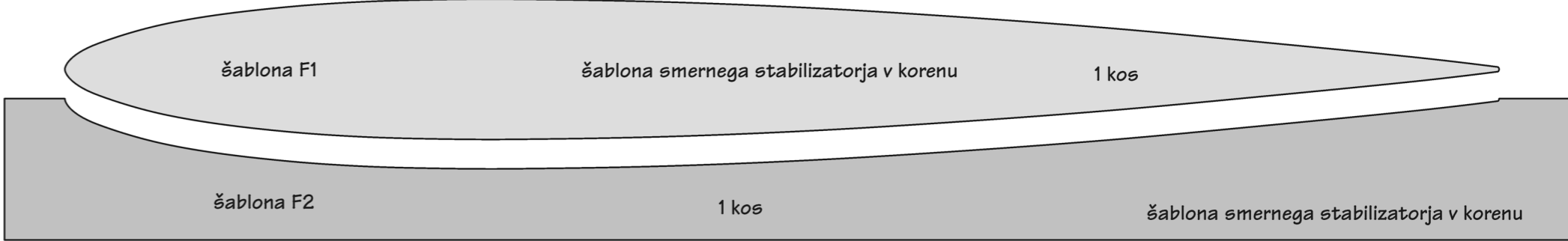

# F-16

M=1:1

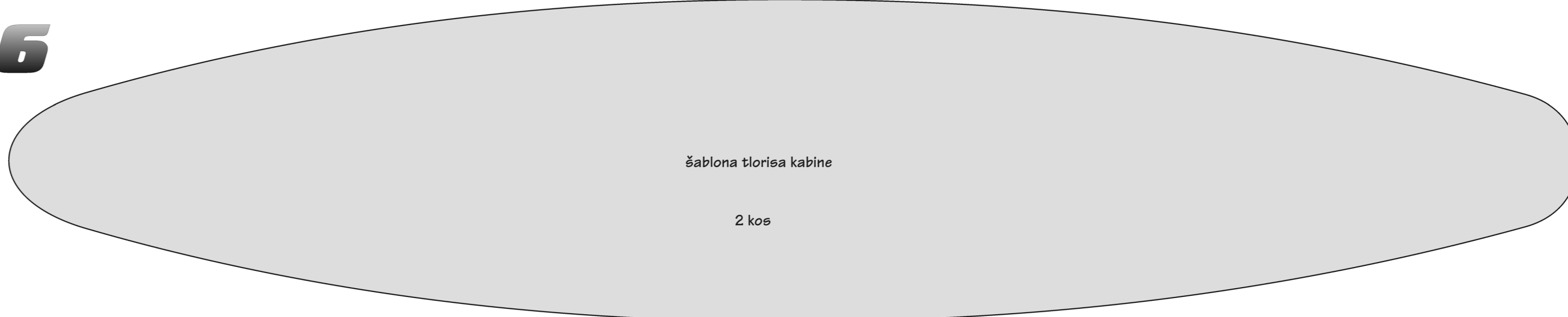
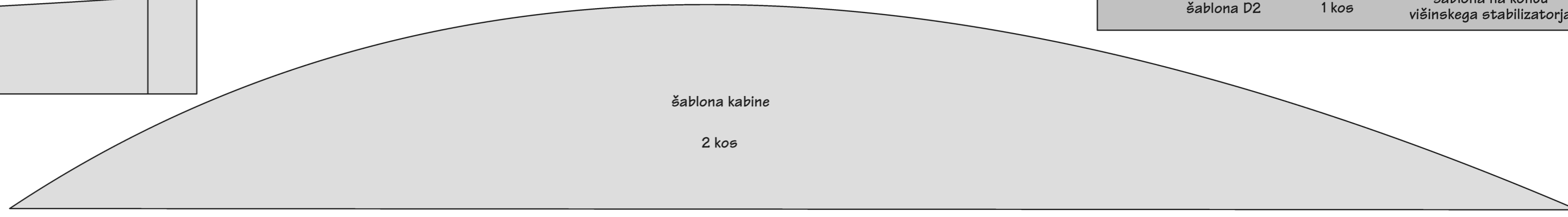

M=1:1

